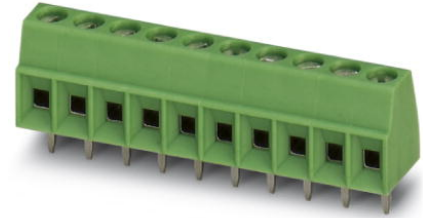

MKDS 1/ 8-3,81

Order No.: 1727078

The figure shows a 10-position version of the product

<http://eshop.phoenixcontact.de/phoenix/treeViewClick.do?UID=1727078>

Printed circuit terminal block, nominal current: 10 A, rated voltage: 160 V, pitch: 3.81 mm, no. of positions: 8, mounting: Soldering, type of connection: Screw connection, connection direction from the conductor to the PCB: 0°

Commercial data

EAN	4017918025540
Pack	50 Pcs.
Customs tariff	85369010
Weight/Piece	0.004274 KG
Catalog page information	Page 49 (CC-2007)

Product notes

WEEE/RoHS-compliant since:
01/01/2003



<http://www.download.phoenixcontact.com>
Please note that the data given here has been taken from the online catalog. For comprehensive information and data, please refer to the user documentation. The General Terms and Conditions of Use apply to Internet downloads.

Technical data

Dimensions / positions

Pitch	3.81 mm
Dimension a	26.67 mm
Number of positions	8

Pin dimensions	0,5 x 0,9 mm
Hole diameter	1.1 mm
Screw thread	M 2
Tightening torque, min	0.22 Nm

Technical data

Insulating material group	I
Rated surge voltage (III/3)	2.5 kV
Rated surge voltage (III/2)	2.5 kV
Rated surge voltage (II/2)	2.5 kV
Rated voltage (III/2)	200 V
Rated voltage (II/2)	400 V
Connection in acc. with standard	EN-VDE
Nominal current I_N	10 A
Nominal voltage U_N	160 V
Nominal cross section	1 mm ²
Maximum load current	12 A
Insulating material	PA
Inflammability class acc. to UL 94	V0
Stripping length	5 mm

Connection data

Conductor cross section solid min.	0.14 mm ²
Conductor cross section solid max.	1.5 mm ²
Conductor cross section stranded min.	0.14 mm ²
Conductor cross section stranded max.	1 mm ²
Conductor cross section stranded, with ferrule without plastic sleeve min.	0.25 mm ²
Conductor cross section stranded, with ferrule without plastic sleeve max.	0.5 mm ²
Conductor cross section stranded, with ferrule with plastic sleeve min.	0.25 mm ²
Conductor cross section stranded, with ferrule with plastic sleeve max.	0.5 mm ²
Conductor cross section AWG/kcmil min.	26
Conductor cross section AWG/kcmil max	16
2 conductors with same cross section, solid min.	0.14 mm ²

2 conductors with same cross section, solid max.	0.5 mm ²
2 conductors with same cross section, stranded min.	0.14 mm ²
2 conductors with same cross section, stranded max.	0.2 mm ²

Certificates / Approvals

Approval logo



CSA

Nominal voltage U _N	300 V
Nominal current I _N	10 A
AWG/kcmil	28-16

CUL

Nominal voltage U _N	300 V
Nominal current I _N	10 A
AWG/kcmil	30-16

UL

Nominal voltage U _N	300 V
Nominal current I _N	10 A
AWG/kcmil	30-16
Certification	CB, CCA, CSA, CUL, GOST, SEV, UL

Accessories

Item	Designation	Description
Marking		
1051993	B-STIFT	Marker pen, for manual labeling of unprinted Zack strips, smear-proof and waterproof, line thickness 0.5 mm
0804109	SK 3,81/2,8:FORTL.ZAHLEN	Marker card, printed horizontally, self-adhesive, 10-section marker strip, 14 identical decades marked 1-10, 11-20 etc. up to 91-(99)100, sufficient for 140 terminal blocks
0805056	SK 3,81/2,8:SO	Marker card, special printing, self-adhesive, labeled acc. to customer requirements, 14 identical marker strips per card, max. 25-position labeling per strip, color: White

Tools

1205037	SZS 0,4X2,5	Screwdriver, bladed, matches all screw terminal blocks up to 1.5 mm ² connection cross section, blade: 0.4 x 2.5 mm
---------	-------------	--

Drawings

Drilling diagram

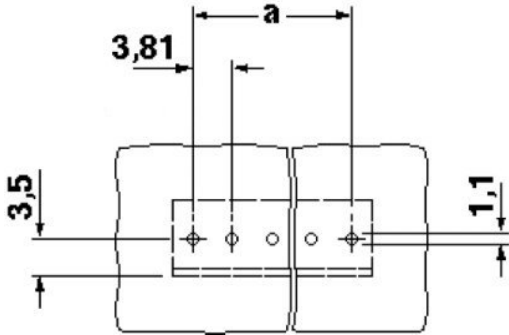

Dimensioned drawing

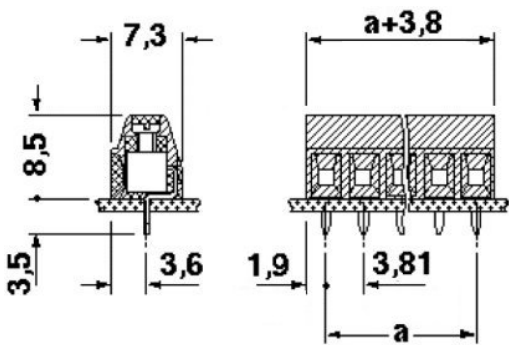

Address

PHOENIX CONTACT GmbH & Co. KG
Flachsmarktstr. 8
32825 Blomberg, Germany
Phone +49 5235 3 00
Fax +49 5235 3 41200
<http://www.phoenixcontact.de>



© 2008 Phoenix Contact
Technical modifications reserved;